

Enclosure series aluCASE

Type: ACF 172

Material-No.: 190.172.000

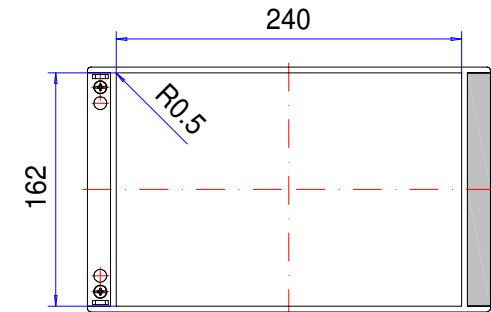
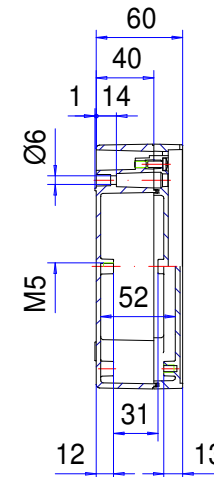
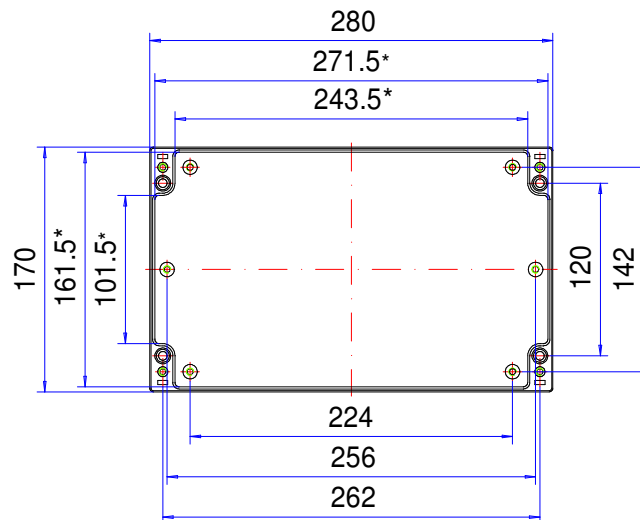
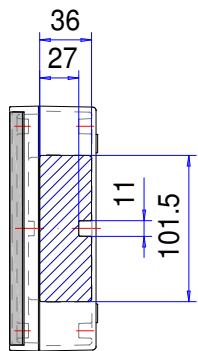
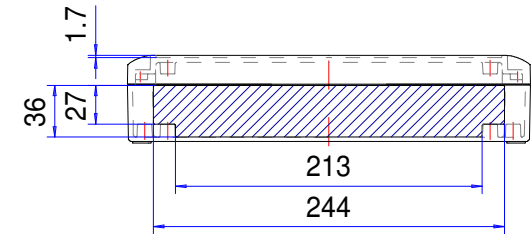
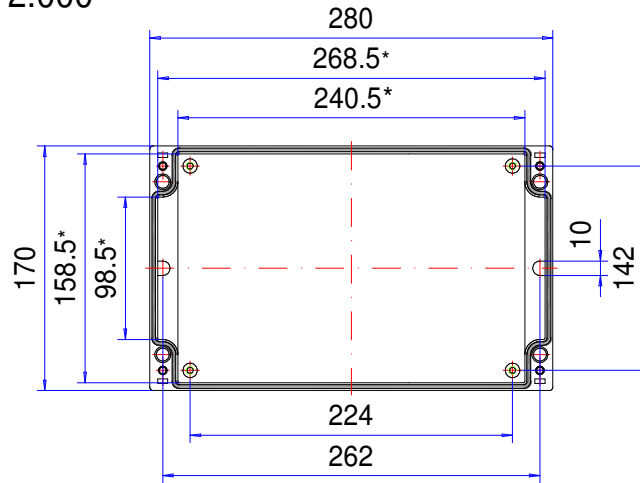

Folie/ Keypad
161.4⁺⁰_{-0.2} x 239.4⁺⁰_{-0.2}

* Please note: Mould slope for casting ejection, dimensions in the amount of the bottom!

Enclosure material	GD-Al Si 12 (DIN 1725)		Gasket	1x TPE moulded gasket, silicone-free, black
Lid screws	4x stainless steel 1.4567 (V2A), captive		Ingress protection	IP67 EN 60529
Assembly screws	5x M5x8, galvanized steel		Weight	1.471 g
Design covers	2x Polyoxymethylene (POM), RAL 7040, window grey		Coating	Powder coating RAL 7040, window grey
Lid supports	2x Polypropylene (PP), window grey		Tolerance	GTA 13/5 DIN 1688-4 (outside dimensions ±0,5mm)