

Enclosure series polyTOP

Type: PT 080

Material-No.: 132.080.000

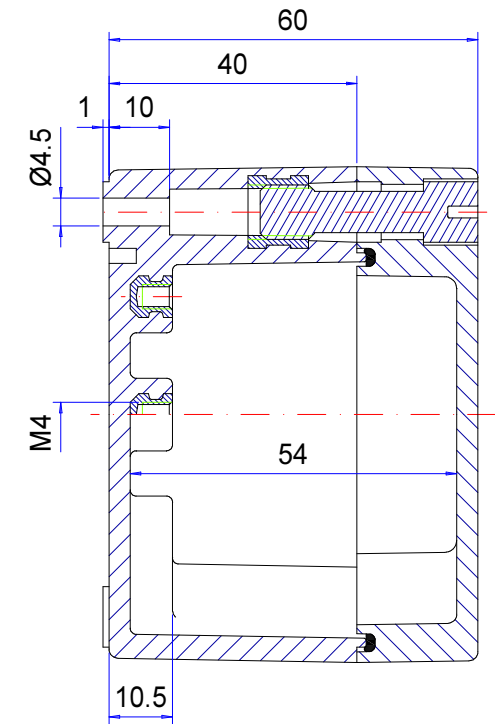
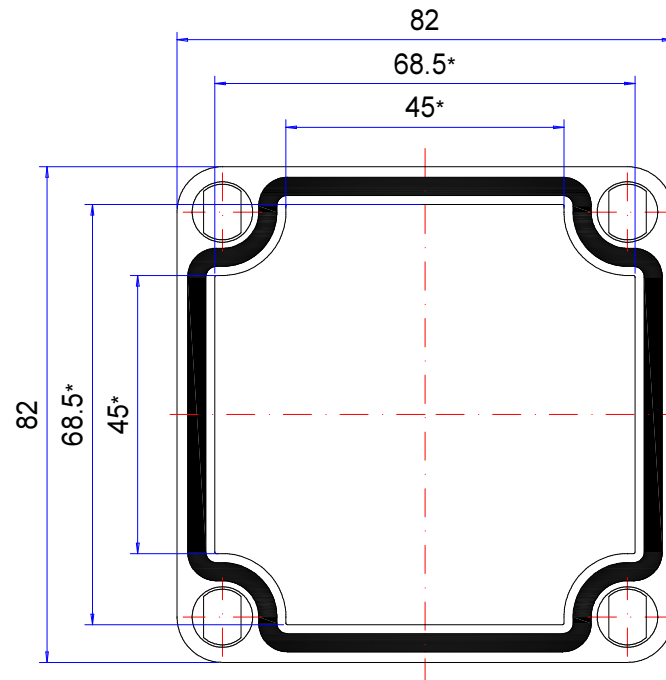
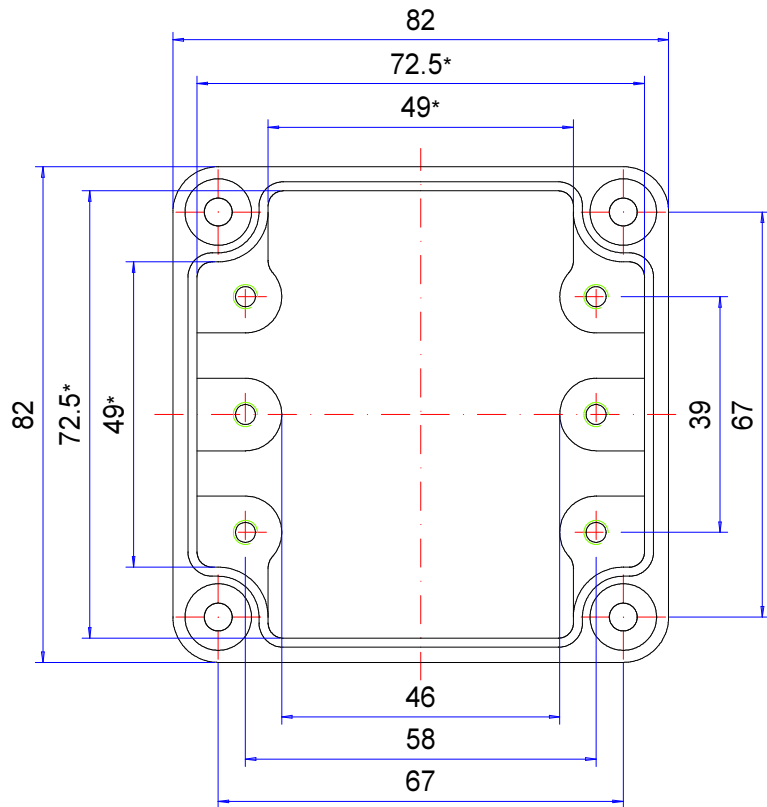

* Please note: Mould slope for casting ejection, dimensions in the amount of the bottom!

Enclosure material	Polyester GrP, UL 94 V-0, RAL 7032, pebble grey		Ingress protection	IP66 EN 60529
Lid screws	4x Polyamide (PA), captive		Weight	240 g
Gasket	1x EPDM, black		Tolerance	DIN ISO 16901 T-130 (outside dimensions ±0,5mm)

132.080.000
polyTOP PT 080



Product overview

Material	Polyester
Protection Class	IP 66/EN 60529, IP 67/EN 60529
Color	RAL 7032
Certifications	CSA (optional), Germanischer Lloyd (optional), UL (optional)
Length (L)	3.23 inch
Width (W)	3.23 inch
Height (H)	2.36 inch
Weight (g)	240 g

polyTOP

THE ROBUST POLYESTER ENCLOSURE

IP 66 - Optional: IP 67

The key product features:

- Enclosure material: glass-fibre reinforced polyester
- Enclosure surface: similar to RAL 7032
- Lid screws in polyamide
- Compatible assembly dimensions with the aluNORM series
- Flammability: UL-94 V0
- Enclosure seal: O-ring gasket (EPDM)

polyTOP is a range of IP 66 enclosures made of highly resistant glass-fibre reinforced polyester. The enclosures are ideal for industrial electronics and control equipment used in harsh indoor and outdoor applications.

Special features include corrosion-resistant polyamide lid fixings in four different designs: slotted (standard), triangular or square head for tamper protection, and hand screws for fast access. Threaded M6 fixing pillars are provided inside for mounting terminal rails, circuit boards, mounting plates etc. polyTOP is available in a wide range of standard sizes. Supporting rails, terminals, cable glands and other accessories are also available.

We can supply polyTOP enclosures fully customized to your requirements.

Enclosure sizes

13

Further information

Improved technology thanks to the single-channel lid and assembly fastening

Compatible assembly dimensions with the aluNORM range

Full protective insulation in accordance with VDE 0100

Enclosure

Polyester glass fiber reinforced, halogen-free

similar to RAL 7032, pebble gray, surface resistance < 10⁹ Ohm

Optional: similar to RAL 9005, deep black, surface resistance < 10⁹ Ohm

1° mold slope for casting ejection > internal circumference dimensions decrease by 1° towards enclosure bottom.

Flammability

UL 94 V-0

Fastening

Single-channel lid and assembly fastening outside of the enclosure interior, stainless steel external mounting brackets

Internal mounting

M4/M6 threaded bushing on the enclosure base

Ingress protection

IP 66 / EN 60529

Optional: IP 67 / EN 60529

Gasket

EPDM O-ring gasket

Optional: Silicone gasket

Lid screws

Polyamide, corrosion-resistant and captive, slotted design

Optional: Various locking screws available

Customizing

Learn more about our [full customizing service for installation-ready enclosures](#)

Full-Service-Products

Customization according to your wishes.



Our passion is enclosures.



Expert advice

Everything begins with individual advice. We'll be pleased to support you with your project and find solutions for every requirement. Customer-specific solutions are our speciality.



Sample service

Test our products with your internal mounting. We'll be pleased to send you a sample enclosure for inspection with no strings attached.



Drilling

We'll manufacture every enclosure for you according to your exact specifications – whether they involve precise drilling or large tolerance.



Milling

Thanks to our modern CNC production, we can quickly and efficiently mill custom-fit cut-outs and contours to match your exact specifications.



Engraving

Our services also include engraving your logo and other elements, which we can of course perform in any colour you desire.



Lasering

We can process stainless steel enclosures and plates quickly and reliably according to your individual requirements thanks to our in-house lasering centre.



Powder coating

We can powder coat enclosures, command enclosures and suspension systems in any RAL colour you desire. Custom colours are of course also possible.



Painting

We can also paint all our enclosures in any RAL colour you desire. The application of primer and special colour structures are possible, as well.



Serigraphy

If desired, we can apply your logo and lettering or other markings using serigraph printing.



Digital printing

Digital printing is particularly worthwhile for low-volume orders and for realising complex patterns or images.



EMC enclosures

We offer our conFORM low-price standard EMC enclosure to protect your internal mounting against electromagnetic radiation. On request, we can also supply an EMC-compliant version of any other ROLEC enclosure.



Displays

We are able to offer the right made-to-measure display for all our enclosures – in varying sizes and degrees of robustness depending on the application.



Accessories

ROLEC's portfolio also includes matching front plates, mounting plate, supporting rails and terminal blocks as well as a range of cable glands, blanking plugs etc.



Assembly

Would you like to have all your components supplied already assembled? No problem. Our assembly team will be pleased to perform all assembly work on your behalf.



Our Service

If you have any requirements for services not listed here, please ask us. Customer-specific solutions are our speciality. We also are keen to take on unusual tasks.

We will help you with those challenges that many others would give up on.