

Enclosure series inoCASE

Type: ICC 302

Material-No.: 175.302.000

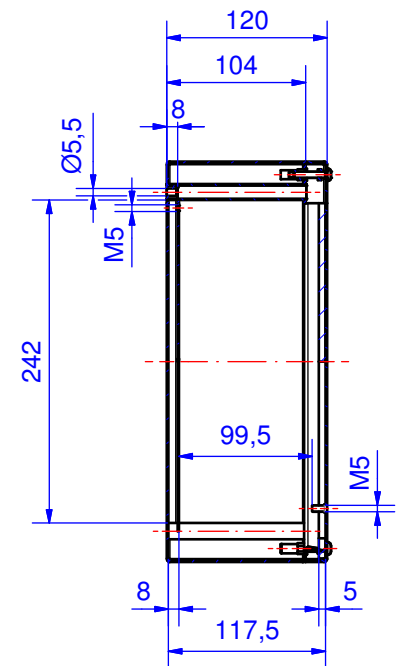
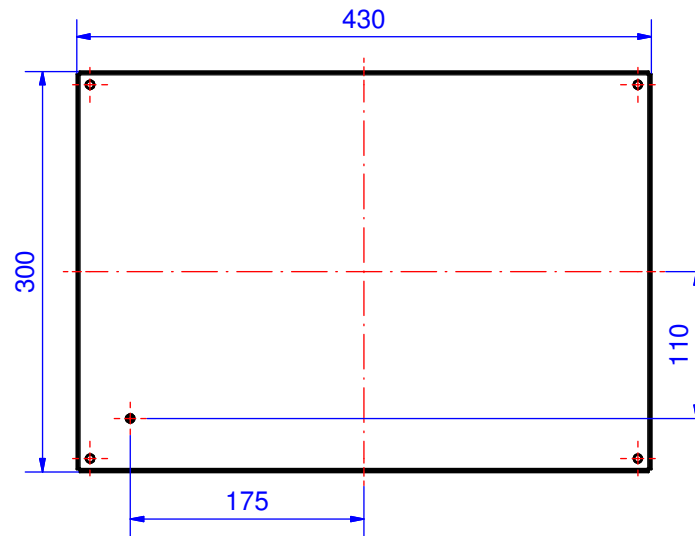
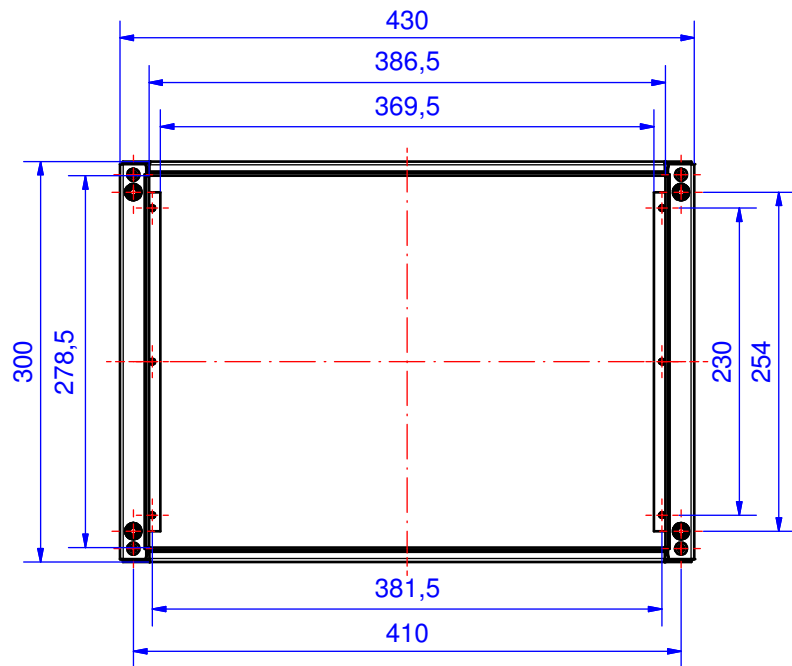

Enclosure material	V4A, 1.4404 (AISI 316L)		Weight	4700 g
Lid screws	4x V4A, captive		Sheet thickness	1,25 mm
Gasket	1x flat gasket, silicone, red		Surface	Grinded, grain size 320
Ingress protection	IP66 EN 60529		Tolerance	DIN ISO 2768-m DIN 6935