

175.112.000
inoCASE ICC 112



technical data

Material	Stainless steel
Protection class	IP 66/67 EN 60529, IP 69K
Colour	Stainless steel Stainless steel
Certifications	GOST, UL (optional)
Length	7.874" 200 mm
Width	4.331" 110 mm
Height	2.362" 60 mm
Weight (g)	1180 g
Country of manufacture	Germany
Customs tariff number	73269098

inoCASE A4

INNOVATIVE A4 STAINLESS STEEL ENCLOSURES GIVE HIGH EQUIPMENT PROTECTION

IP 66, IP 67 - Optional: IP 69K

inoCASE 1.4404/A4 stainless steel enclosures provide very high performance protection for industrial and marine equipment.

Features include captive lid screws, injected full-silicone gaskets and fastening brackets in the base for attaching circuit boards, terminal rails, mounting plates etc. The enclosures are mounted without the need for external brackets or holes in the sealed interior. There is also an earthing bolt attached to the lid. Cable glands, mounting plates and other accessories are also available.

For small order quantities, we can take stock enclosures and add holes and cutouts using our in-house laser processing centre. Thus offering maximum flexibility for products required at short notice. Larger volumes are fully made to order.

Enclosure sizes
18 versions

Dimensions L x W x H

5,51" x 4,33" x 2,36" to 16,92" x 11,81" x 4.72"

Further information

1.4404/A4, international designation: AISI 316L

Open Deck approval from Det Norske Veritas – Germanischer Lloyd

Assembly with separate fastening channels, outside the sealed chamber

Enclosure

Stainless sheet steel, edged and welded, 1.4404 (AISI 316L) V4A alloy, sheet thickness 1.25mm

Fastening

Separate fastening channels

Internal mounting

Fastening thread M5 in the enclosure base, M5 earthing bolt in the lid

Ingress protection

IP 66, IP 67 / EN 60529

Optional: IP 69 K / ISO 20653

Gasket

Silicone gasket, temperature resistance:- 40°C to 80°C

Lid screws

Stainless steel, captive, Allen screw

Surface

Polished, grain: 240

Optional: Electro-polished

Customizing

Learn more about our full customizing service for installation-ready enclosures

Enclosure series inoCASE

Type: ICC 112

Material-No.: 175.112.000

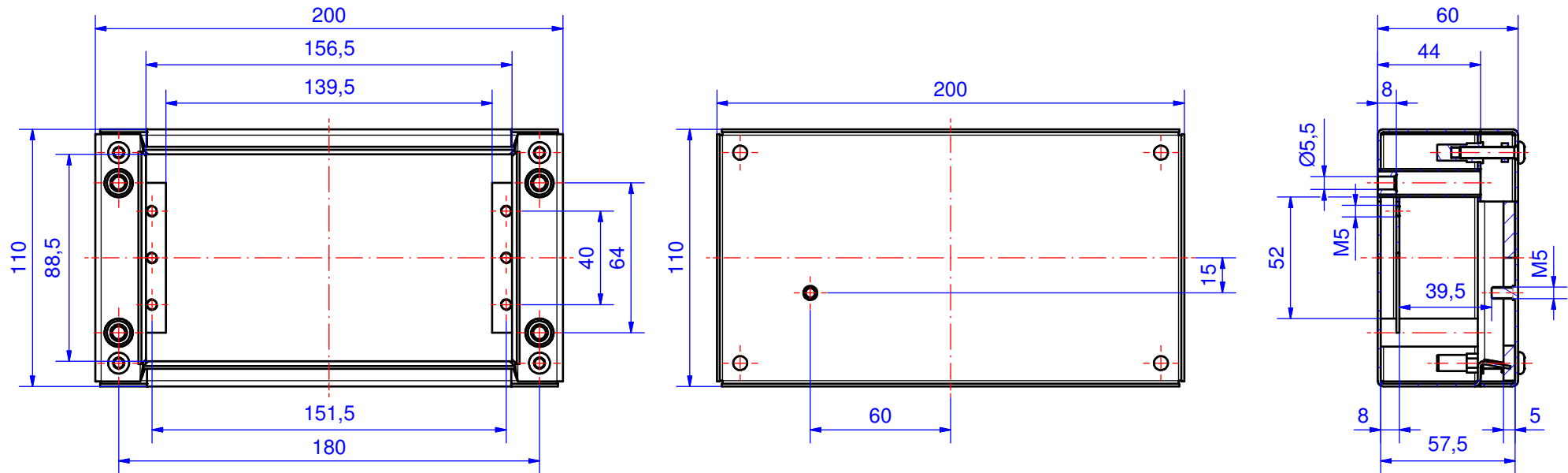

Enclosure material	V4A, 1.4404 (AISI 316L)		Weight	1180 g
Lid screws	4x V4A, captive		Sheet thickness	1,25 mm
Gasket	1x flat gasket, silicone, red		Surface	Grinded, grain size 320
Ingress protection	IP66 EN 60529		Tolerance	DIN ISO 2768-m DIN 6935