

Enclosure series technoBOX

Type: TBA 120

Material-No.: 220.120.000

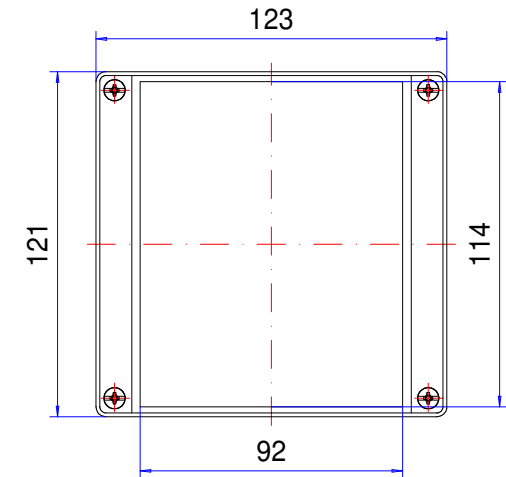
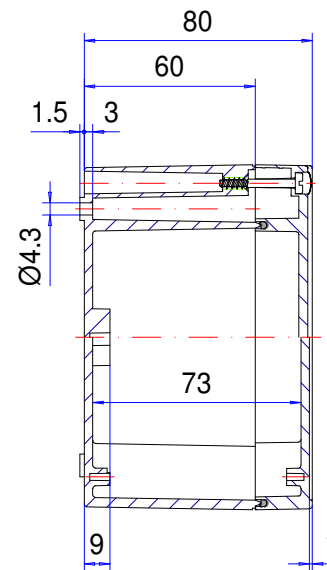
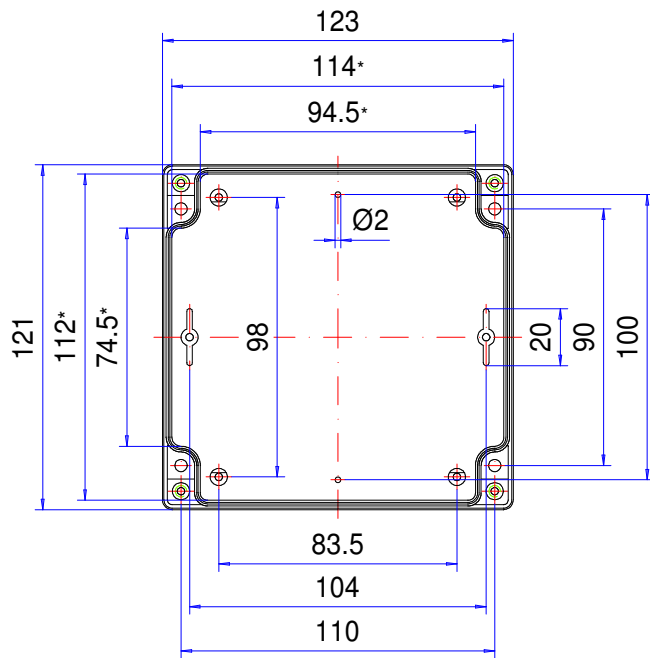

Folie/ Keypad
 $113.8^{+0}_{-0.2} \times 91.8^{+0}_{-0.2}$

* Please note: Mould slope for casting ejection, dimensions in the amount of the bottom!

Enclosure material	ABS, UL 94 HB, RAL 7035, light grey		Weight	240 g
Lid screws	4x stainless steel 1.4567 (V2A), captive		Assembly screws	4x KBL Ø3x6, galvanized steel
Gasket	1x Chloroprene (CR), light grey		Surface	Mirror finished
Ingress protection	IP66 EN 60529		Tolerance	DIN ISO 16901 T-130 (outside dimensions ±0,5mm)

220.120.000
technoBOX TBA 120



Product overview

Material	ABS
Protection Class	IP 66/EN 60529
Color	RAL 7035
Length (L)	4.84 inch
Width (W)	4.76 inch
Height (H)	3.15 inch
Weight (g)	240 g

technoBOX

THE MULTIVARIABLE, THERMOPLASTIC ENCLOSURE

IP 66

The key product features:

- Enclosure material: ABS
- Enclosure surface: similar to RAL 7035
- Alternative design due to slanted lid edges
- Integrated recess in the lid for a membrane keypad or front plate
- Lid screws stainless steel 1.4567
- Fire protection class UL-94 HB
- Enclosure seal: O-ring gasket (CR)

technoBOX is a modern and inexpensive range of plastic enclosures for all types of electronics and electrical equipment. It is molded in tough and long life ABS. The bevelled lid gives the housing an attractive appearance. A recess is provided in the lid for fitting a membrane keypad, front plate or product label. Threaded screw bosses in the lid and base can be used for fitting circuit boards, mounting plates, terminal rails etc. Mounting plates, front plates, cable glands and other accessories are also available.

We can supply technoBOX enclosures fully customized to your requirements.

Enclosure sizes

10

Further information

Smart, modern design with bevelled lid

Fastening points compatible with standard enclosures

Integrated recess in the lid for membrane keypad or front plate

Optional external mounting brackets can be rotated by 90°

Full protective insulation in accordance with VDE 0100

Enclosure

ABS halogen-free, similar to RAL 7035 light gray

1° mold slope for casting ejection > internal circumference dimensions decrease by 1° towards enclosure base

Special materials and colors on request

Flammability

UL 94 HB

Fastening

Separate screw channels outside the enclosure interior

Internal mounting

Fastening option for self-tapping screws on the base of the enclosure and in the lid

Ingress protection

IP 66 / EN 60529

Gasket

Chloroprene O-ring gasket (CR)

Lid screws

Stainless steel 1.4567, captive

Customizing

Learn more about our [full customizing service for installation-ready enclosures](#)

Full-Service-Products

Customization according to your wishes.



Our passion is enclosures.



Expert advice

Everything begins with individual advice. We'll be pleased to support you with your project and find solutions for every requirement. Customer-specific solutions are our speciality.



Sample service

Test our products with your internal mounting. We'll be pleased to send you a sample enclosure for inspection with no strings attached.



Drilling

We'll manufacture every enclosure for you according to your exact specifications – whether they involve precise drilling or large tolerance.



Milling

Thanks to our modern CNC production, we can quickly and efficiently mill custom-fit cut-outs and contours to match your exact specifications.



Engraving

Our services also include engraving your logo and other elements, which we can of course perform in any colour you desire.



Lasering

We can process stainless steel enclosures and plates quickly and reliably according to your individual requirements thanks to our in-house lasering centre.



Powder coating

We can powder coat enclosures, command enclosures and suspension systems in any RAL colour you desire. Custom colours are of course also possible.



Painting

We can also paint all our enclosures in any RAL colour you desire. The application of primer and special colour structures are possible, as well.



Serigraphy

If desired, we can apply your logo and lettering or other markings using serigraph printing.



Digital printing

Digital printing is particularly worthwhile for low-volume orders and for realising complex patterns or images.



EMC enclosures

We offer our conFORM low-price standard EMC enclosure to protect your internal mounting against electromagnetic radiation. On request, we can also supply an EMC-compliant version of any other ROLEC enclosure.



Displays

We are able to offer the right made-to-measure display for all our enclosures – in varying sizes and degrees of robustness depending on the application.



Accessories

ROLEC's portfolio also includes matching front plates, mounting plate, supporting rails and terminal blocks as well as a range of cable glands, blanking plugs etc.



Assembly

Would you like to have all your components supplied already assembled? No problem. Our assembly team will be pleased to perform all assembly work on your behalf.



Our Service

If you have any requirements for services not listed here, please ask us. Customer-specific solutions are our speciality. We also are keen to take on unusual tasks.

We will help you with those challenges that many others would give up on.