

Suspension-System profiPLUS 50

Type: Elbow console coupling N, standing

Material-No.: 142.038.000

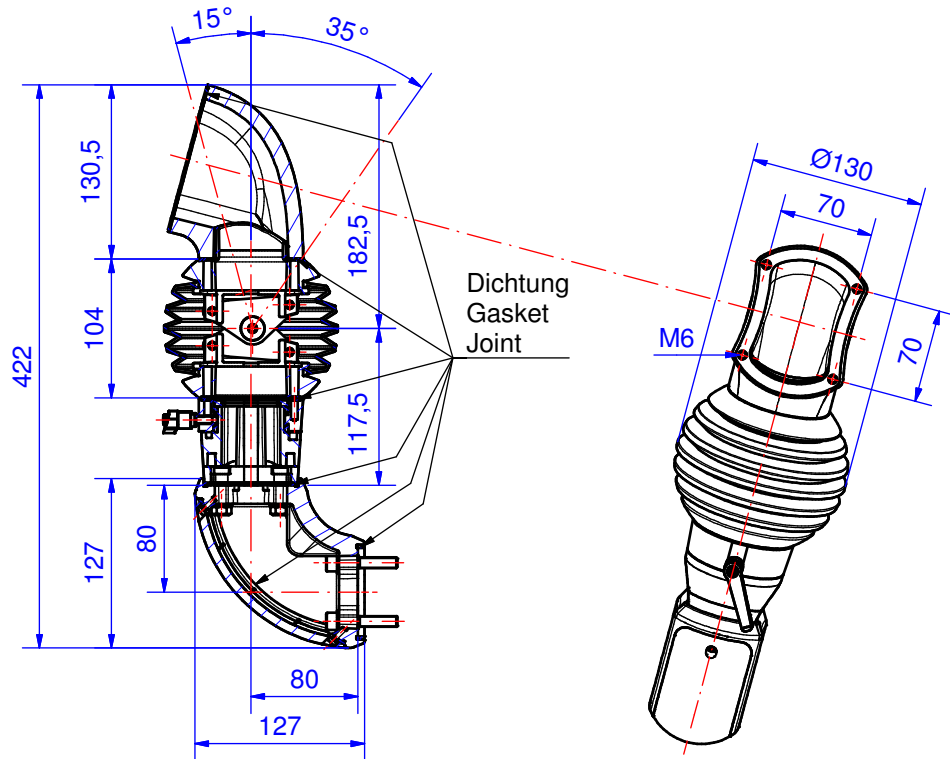

Suspension system material	GD-Al Si 12 (DIN 1706)		Bending range	310°
Gasket	6x Chloroprene (CR), black		Weight	3.240 g
Mounting screws	4x M8, 4x M6, galvanized steel		Surface	Powder coating RAL 7035, light grey
Ingress protection	IP54 EN 60529		Tolerance	GTA 13/5 DIN 1688-4 (outside dimensions $\pm 0,8\text{mm}$)